

1 Tonne Hi Tip

KEY FEATURES & BENEFITS - MACH201



Market leading and the hirers favourite, the Thwaites 1 Tonne Hi Tip, Stage V dumper is easily transported by trailer. This is the ideal machine when working in confined spaces or with limited access.

Powered by a 15.9 Kw Yanmar engine, delivering 66.4 Nm of torque for optimum traction, the Thwaites 1 Tonne range can perfectly match your needs with the following alternative build option:

- › Power Swivel Skip (see MACH202)

This dumper is 1115 mm wide for optimum stability, but can be specified with optional narrow wheels, for an overall width of just 982 mm, making it ideal for narrow access jobs, and is driven by a Hydrostatic Transmission making it very easy to operate.

The compact Thwaites 1 Tonne Hi-Tip dumper is an effective and efficient skip loader, ideal for use in the building of house extensions and property landscaping, providing contractors and hirers with amazing versatility and improved performance.

Safe, compliant and competitive.



Snap this QR code from your smart phone for more information



Thwaites

Thwaites Ltd, Leamington Spa,
Warwickshire, CV32 7NQ, England
Tel +44 (0)1926 422471

www.thwaitesdumpers.co.uk



GET THE JOB DONE.

1 Tonne Hi Tip

DIMENSIONS & SPECIFICATIONS - MACH201

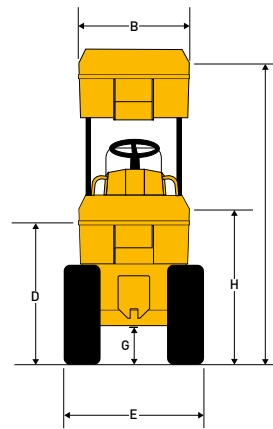
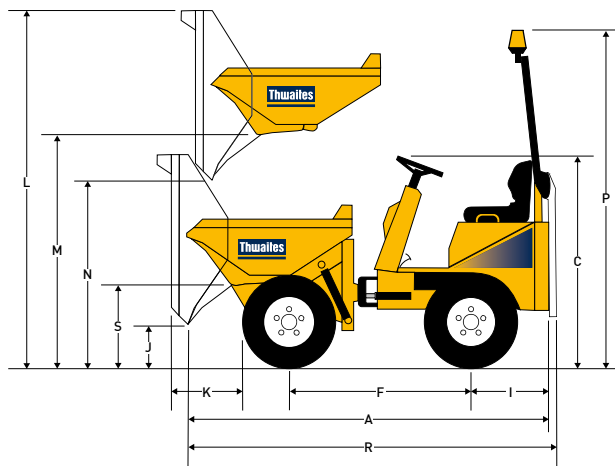

(mm)

A	3032	N	1573
B	982	P	2860
C	1773	R	3192
D	1155	S	720
E	1115*		
F	1500		
G	274		
H	1262		
I	654		
J	346		
K	505		
L	3005		
M	1913		

*982 with optional narrow wheels

Weight	Unladen	1295 kg
	Shipping	1281 kg

Capacities	Max safe load	1000 kg
	Heaped	500 litres
	Struck	400 litres
	Water	280 litres

Engine

- › Yanmar 3TNV76, 3-cylinder, water-cooled diesel
- › Power 15.9 kW/21.4 bhp at 2800 rpm
- › Torque 66.4 Nm (49 lbf ft)

Noise Levels

- › Operator's ear 84 LpA / airborne level 101 LwA

Transmission

- › Hydrostatic with variable displacement pump feeding four wheel motors, incorporating "Twin-Lock" system to maximise traction

Speeds	Forward and Reverse
	0 - 12 km/h (0 - 7.5 mph)

Brakes and Axles

- › Automatic failsafe braking system incorporated into rear drive motors

Chassis

- › Front and rear chassis constructed from folded steel plate, with centre-point articulation and oscillation for optimum stability and traction

Skip

- › Hydraulically operated, 3 mm base, 4 mm sides steel plate.
- › Skip mouth reinforced with box sections
- › Hi-Tip scissor lift mechanism

Seating & Controls

- › Adjustable suspension seat with high-vis seat belt
- › LED warning lights for all critical functions

Service Access

- › Lockable engine cover provides easy access from ground level to engine service points.

Electrics

- › Wiring harness contained within conduits
- › All electrical components water resistant to IP67 rating

Steering and Hydraulics

- › Hydraulic power steering
- › Return line filtration for all services
- › Hydraulic test point fitted as standard

Tank Capacities	Fuel	21 litres
	Hydraulic	20 litres

Turning Circle	5.45m
----------------	-------

Standard Equipment

- › LED Beacons
- › Reverse alarm

Optional Equipment

- › Road mirrors
- › Wheel nut indicator
- › Road lights
- › Towing bracket
- › Sand tyres and narrow tyres

Thwaites

Thwaites Ltd, Leamington Spa,
Warwickshire, CV32 7NQ, England
Tel +44 (0)1926 422471

www.thwaitesdumpers.co.uk



Images are representative, but specific details or equipment may vary by country. We reserve the right to change any and all specifications without prior notice. 12/2020